

Data Sheet

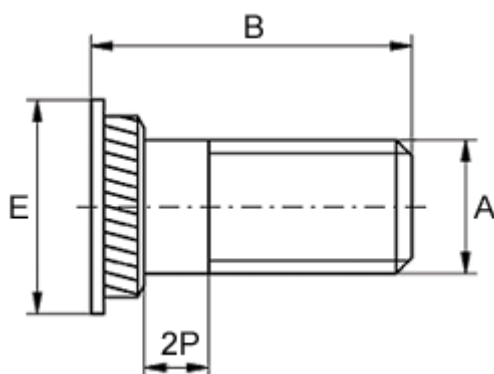

Article number: 12516700030100
Description: KLEE-coil 516 700 030.100
M3 Hardened, zinc-pl.

Measures



For plate thickness, min	= 1.5
Head diameter E	= 6
Hole diameter +0.1	= 4.2
Length B	= 16
Male thread A	= M3x0,5
Min distance to edge	= 2.4